

# POOL color guide

reviglass  
mosaic







# Index

**Color guide** 04

**Luminis** 30

**Projects** 32

**Antislip** 40

**Trim** 41

**P.U. Cord** 42

**Collections** 43





**ESP** Desde 1985, en **Reviglass** ofrecemos acabados con estilo y calidad para piscinas de todo el mundo.

**Nuestro mosaico** está fabricado en nuestras instalaciones en el corazón de Gipuzkoa (Norte de España) utilizando un **100% de vidrio reciclado** como materia prima. El resultado es un material duradero y de fácil instalación, ideal para el revestimiento de todo tipo de piscinas.

**Pool Color Guide** es una recopilación de fotos de piscinas revestidas con nuestros mosaicos que tiene la intención de servir de guía e inspiración para nuevas construcciones y rehabilitaciones. Podrán comprobar en ellas la riqueza de matices que se generan en el color del agua por influencia de su profundidad, del entorno, y de la elección de la junta.

**ENG** At **Reviglass**, we have been providing high quality and elegant finishes to pools all around the world since 1985.

**Our mosaic tile** is produced in our installations located in the heart of Gipuzkoa (North of Spain) using **100% recycled glass** and our goal is to offer an easy-to-install and long-lasting product, ideal to cover all kinds of pools.

**Pool Color Guide** is a picture compilation of pools made with our mosaic tiles to serve as guidance and inspiration for new constructions and restorations. We invite you to note the wealth of shades produced by the depth of the pool, the environment, and the grout color.

**FR** Depuis 1985, chez **Reviglass**, nous proposons des finitions élégantes et de qualité pour les piscines du monde entier.

**Notre mosaïque** est fabriquée dans nos installations au cœur de Gipuzkoa (nord de l'Espagne) en utilisant du **verre 100% recyclé** comme matière première. Le résultat est un matériau durable et facile à installer, idéal pour l'habillage de tout genre de piscines.

**Pool Color Guide** est une collection d'images de piscines carrelées avec nos mosaïques qui est destinée à servir de guide et d'inspiration pour les nouvelles constructions et les rénovations. Vous pourrez y vérifier la richesse des nuances générées dans la couleur de l'eau en raison de l'influence de leur profondeur, de l'environnement et du choix du joint.





**Golden**  
*sand*



**KA-02** 6  
TRAVERTINE



**KA-10** 6  
WALLIS

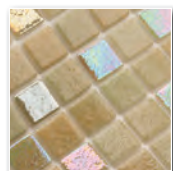

**MIX IRIS** 4  
SENA

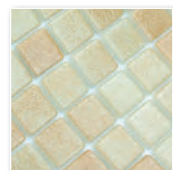

**DK-70** 4



**DK-74** 4

Color junta - Grout color - Joint couleur :

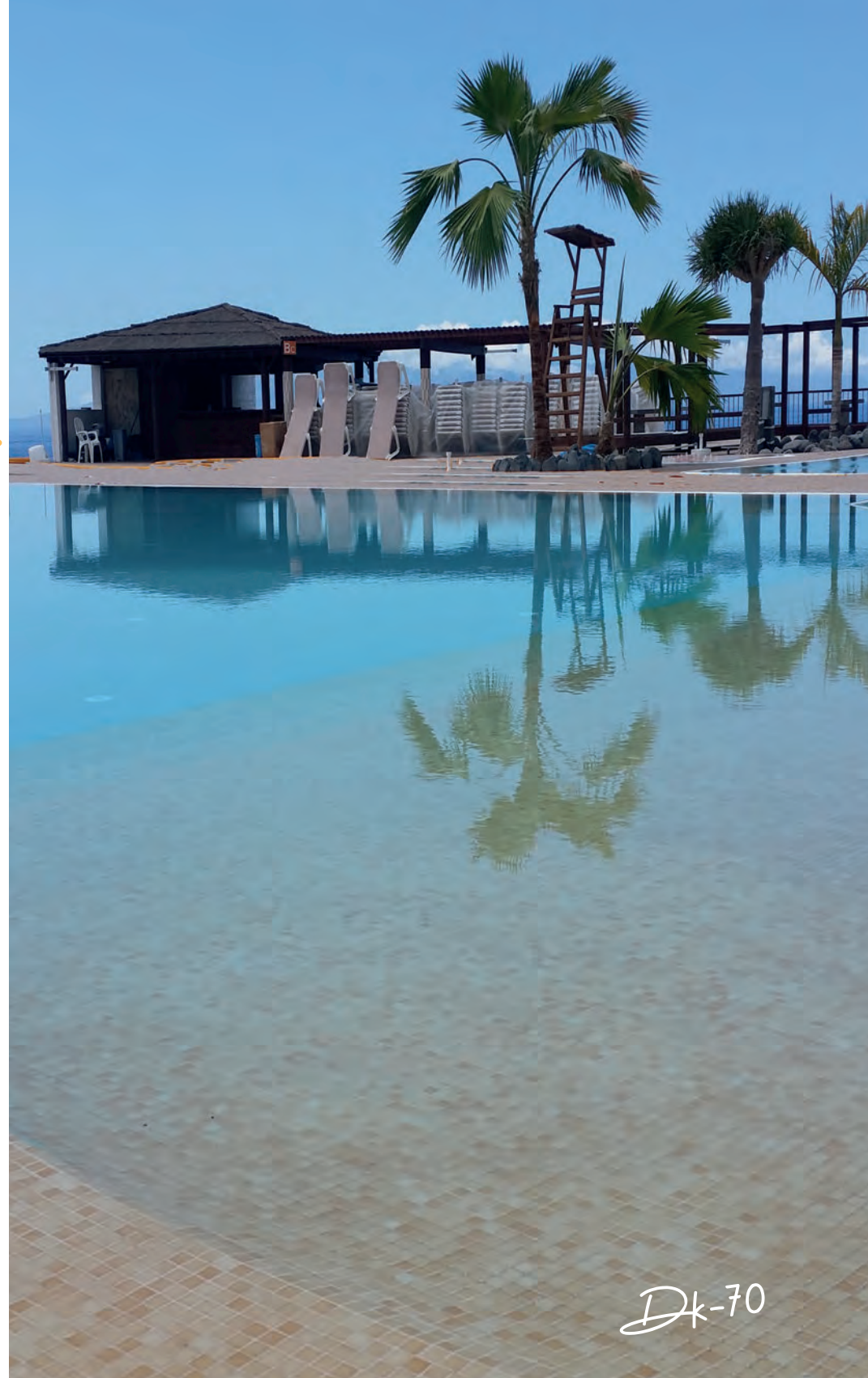

*DK-70*





Dk-74



Dk-74





□ □ KA-11 6  
CORAL



□ □ KA-12 6  
AQUARELA



□ □ PA-09 5  
SANDSTONE



□ □ SAMOA 4

Color junta - Grout color - Joint couleur :

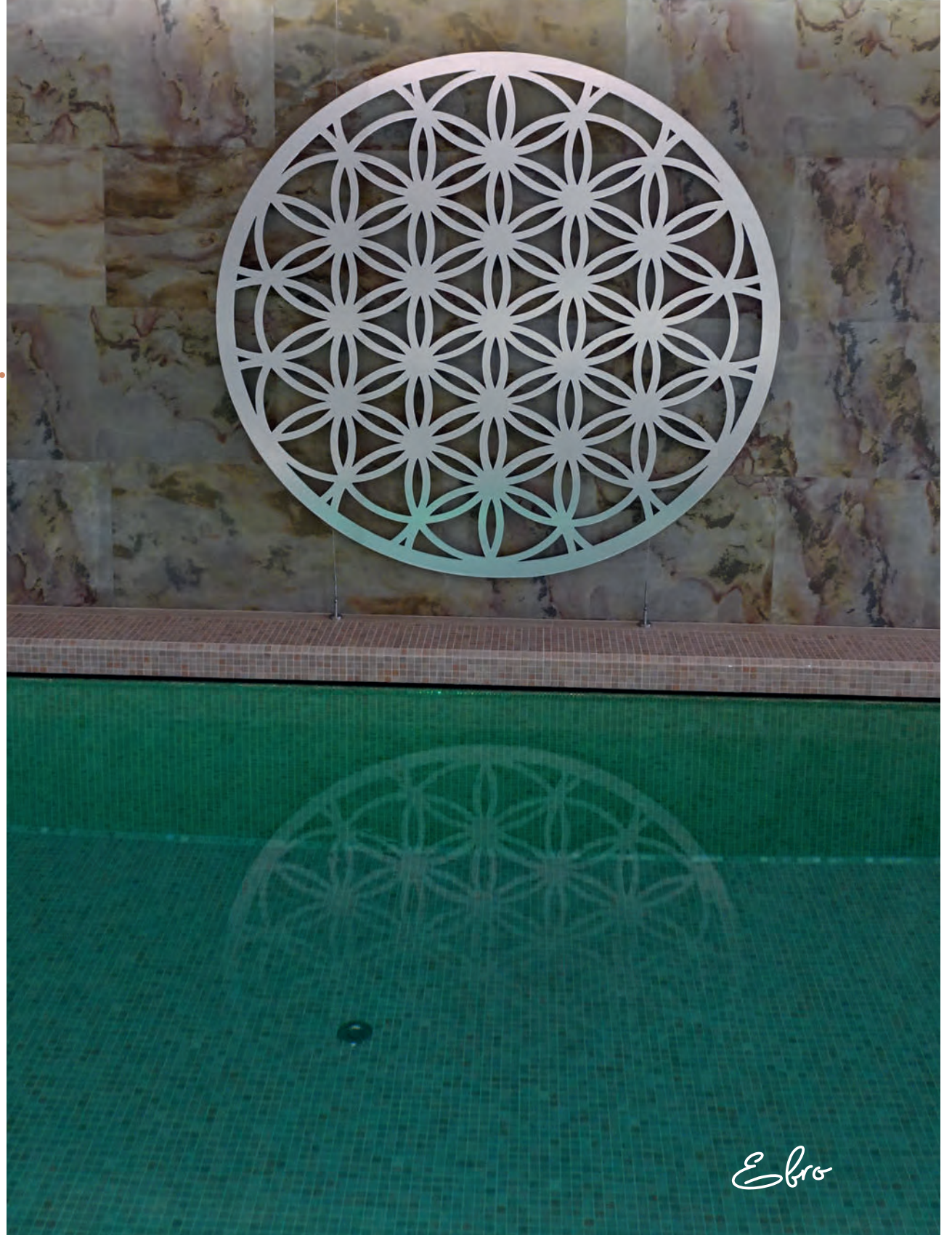





*Ebro*



□ MIX IRIS 4  
EBRO

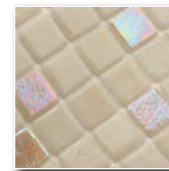

□ MIX IRIS 4  
TIBER

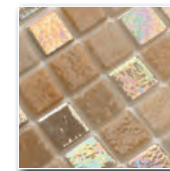

□ MIX IRIS 4  
ORINOCO

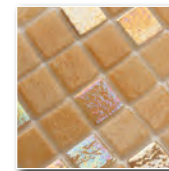

□ MIX IRIS 4  
TAMESIS

Color junta - Grout color - Joint couleur :





**KA-01 6**  
CALACATTA

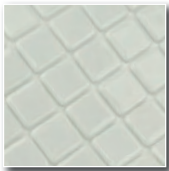

**PS-25 1**

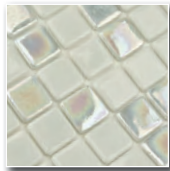

**MIX IRIS 3**  
ERNIO



**AB-02 2**

Color junta - Grout color - Joint couleur :

*ps-25*









□ PS-21 1

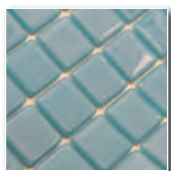

□ PS-22 1

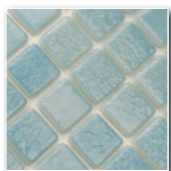

□ PS-41 1



□ PS-50 1

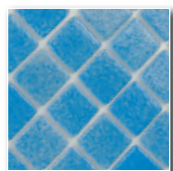

□ PS-51 1

Color junta - Grout color - Joint couleur :



PS-41





□ AB-03 **2**

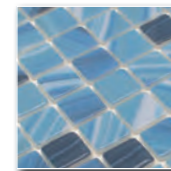

□ KA-05 **6**  
URA



□ MIX IRIS **3**  
ORIA



□ PS-50 **2**  
IRIS



□ TAHITI **4**

Color junta - Grout color - Joint couleur :





Ocean  
*dream*

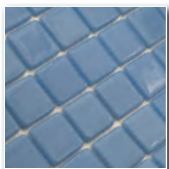

PS-23 **1**

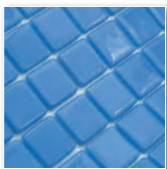

PS-24 **1**

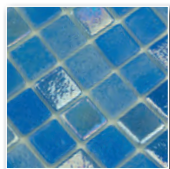

MIX IRIS **3**  
URUMEA



PA-01 **5**  
AGUAMARINA

Color junta - Grout color - Joint couleur :

*ps-50*





*Urumea*



*PS-53*



□ PS-52 **1**



□ PS-53 **1**

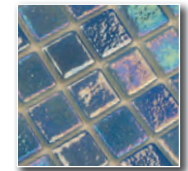

□ PS-53 **2**  
IRIS

Color junta - Grout color - Joint couleur :



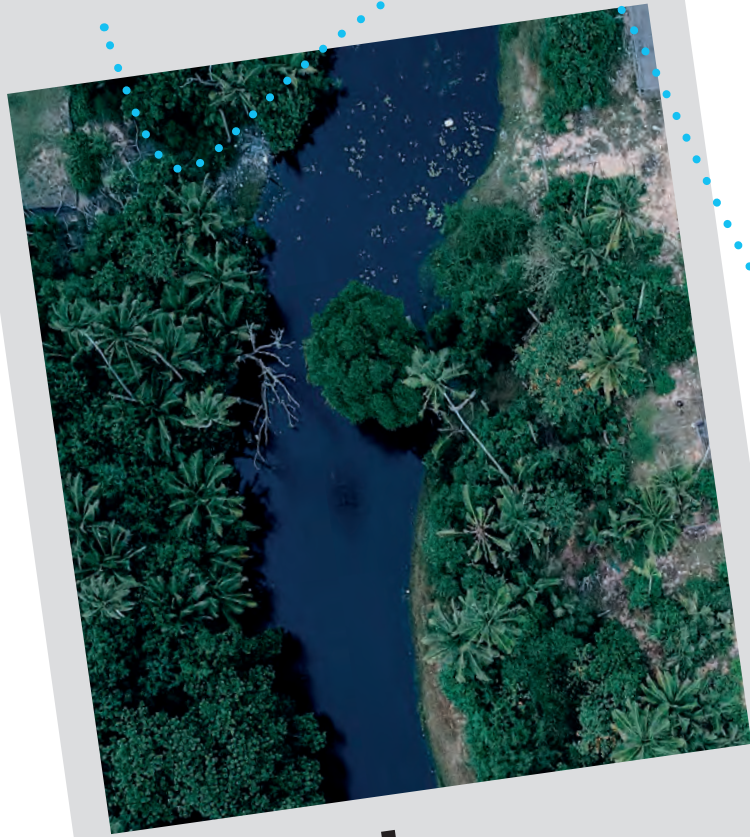

# Atlantic *shore*

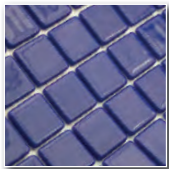

PS-27 **1**

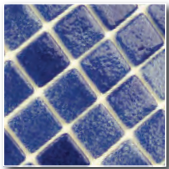

PS-55 **1**



PS-60 **1**

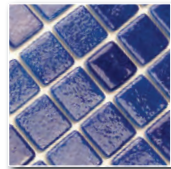

PS-63 **1**

Color junta - Grout color - Joint couleur :

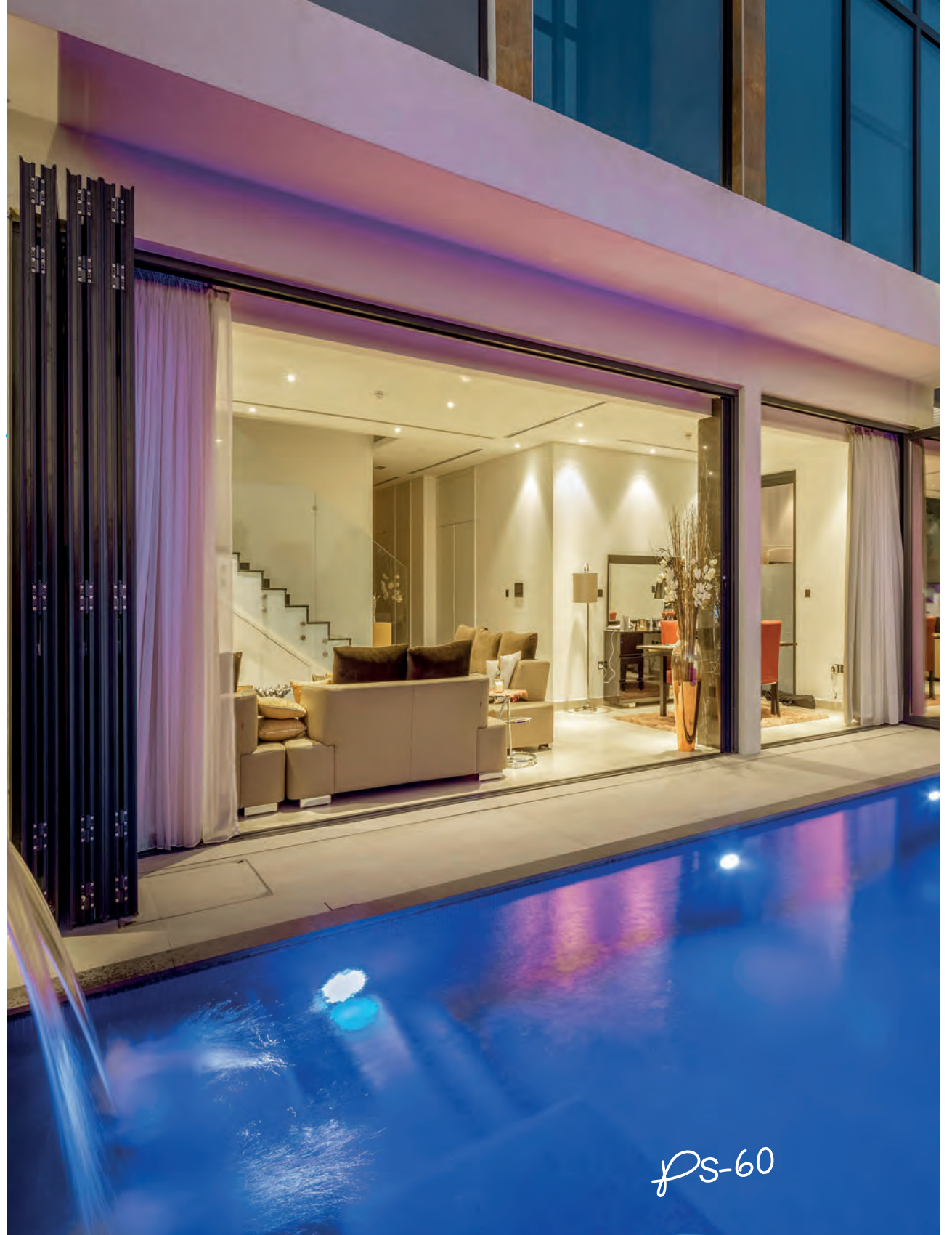

*ps-60*





ps-55



□ □ KA-09 **6**  
BLUE MOON

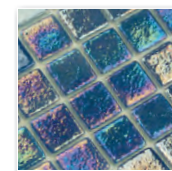

□ PS-55 **2**  
IRIS

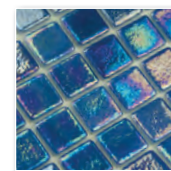

□ PS-60 **2**  
IRIS

Color junta - Grout color - Joint couleur : 



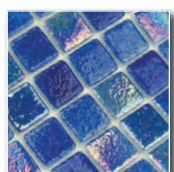

**MIX IRIS 3**  
UROLA

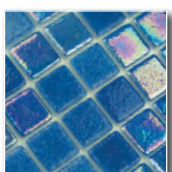

**MIX IRIS 3**  
DEBA

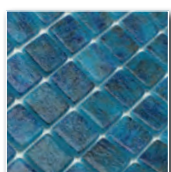

**PA-03 5**  
ZAFIRO

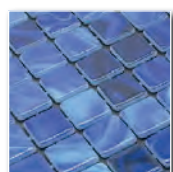

**KA-06 6**  
MOANA

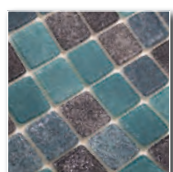

**PA-10 5**  
TURQUESE LAGOON

Color junta - Grout color - Joint couleur :



Urola





*Turquoise Lagoon*



*Zafiro*





# Highland creek

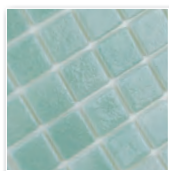

□ □ PS-40 1

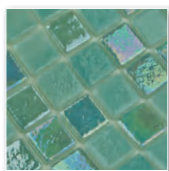

□ □ MIX IRIS 3  
CHAVON

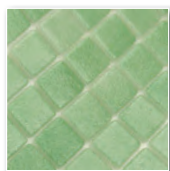

□ □ DK-84 4

Color junta - Grout color - Joint couleur :



PS-40





Chavon

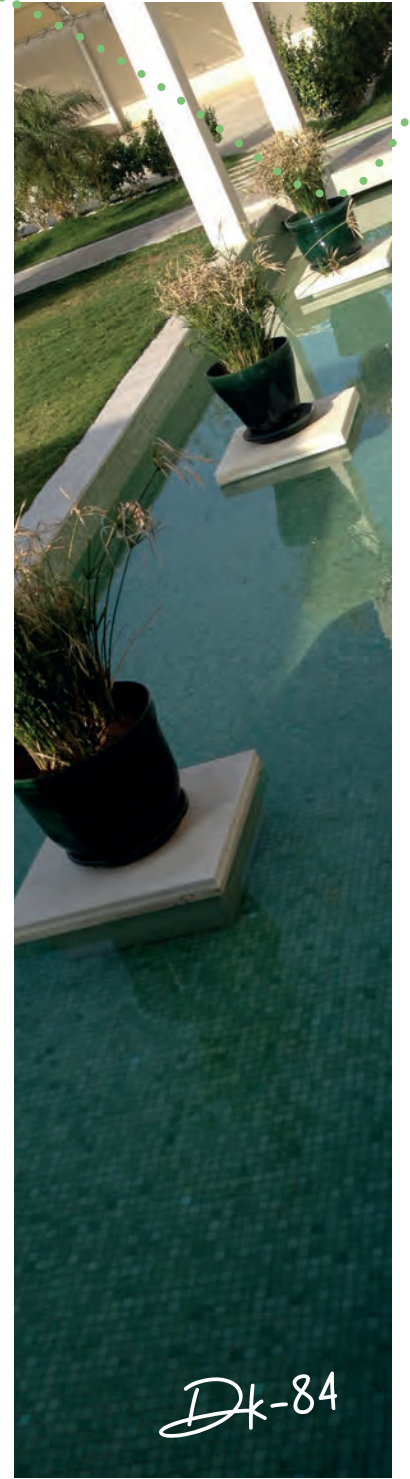

Dk-84





# Far East

*memories*

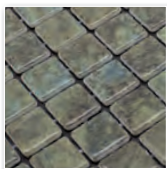

**KA-07 6**  
BALI STONE

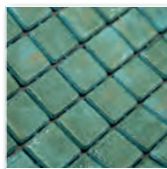

**PA-02 5**  
JADE

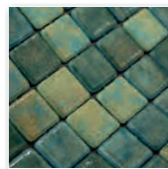

**PA-04 5**  
SANDY BALI

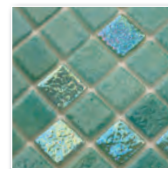

**MIX IRIS 4**  
INDO

Color junta - Grout color - Joint couleur : 

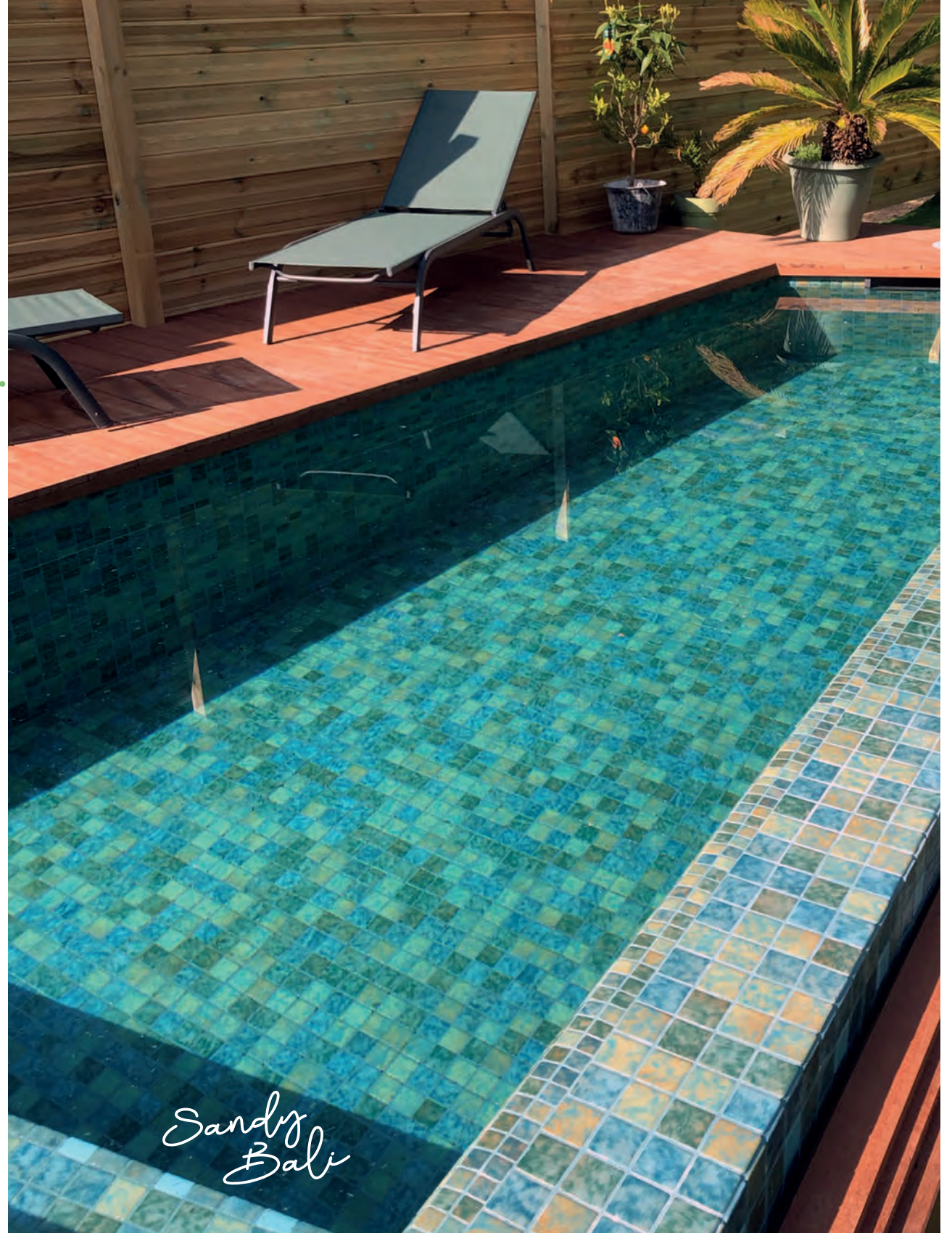

*Sandy Bali*



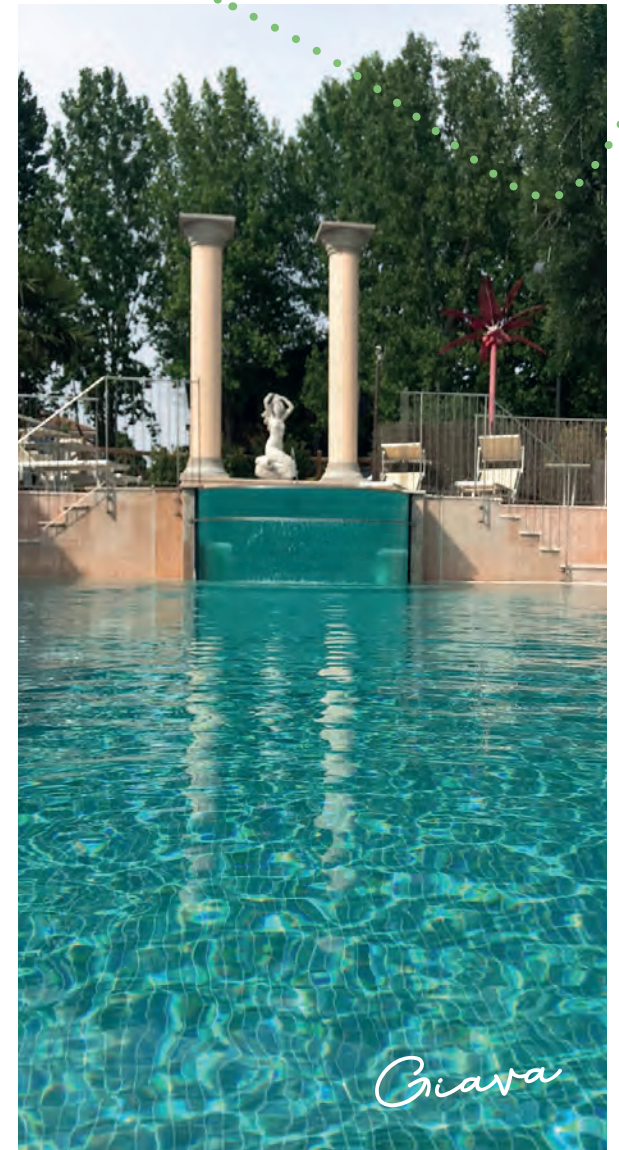

□ MIX IRIS 4  
TIGRIS

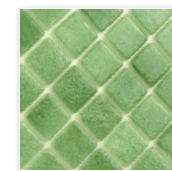

□ PS-59 1



□ GIAVA 4

Color junta - Grout color - Joint couleur : 





# Cenote *diving*

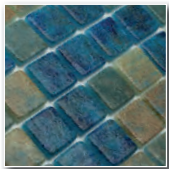

□ PA-05 **5**  
BLUE BALI

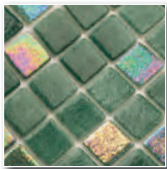

□ MIX IRIS **4**  
DANUBIO

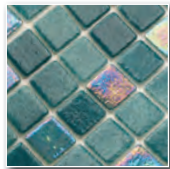

□ MIX IRIS **4**  
NILO

Color junta - Grout color - Joint couleur : 



*Danubio*





*DK-87*

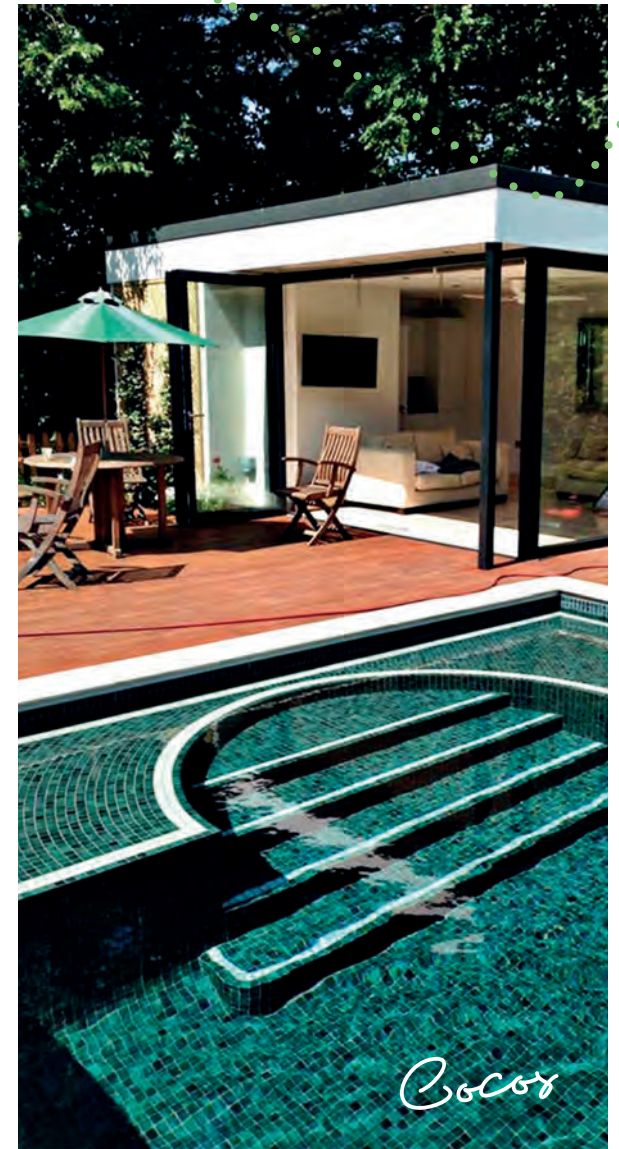

*COCOS*

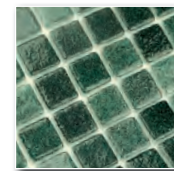

COCOS 4



PS-56 1

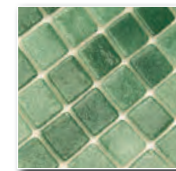

DK-87 4

Color junta - Grout color - Joint couleur :



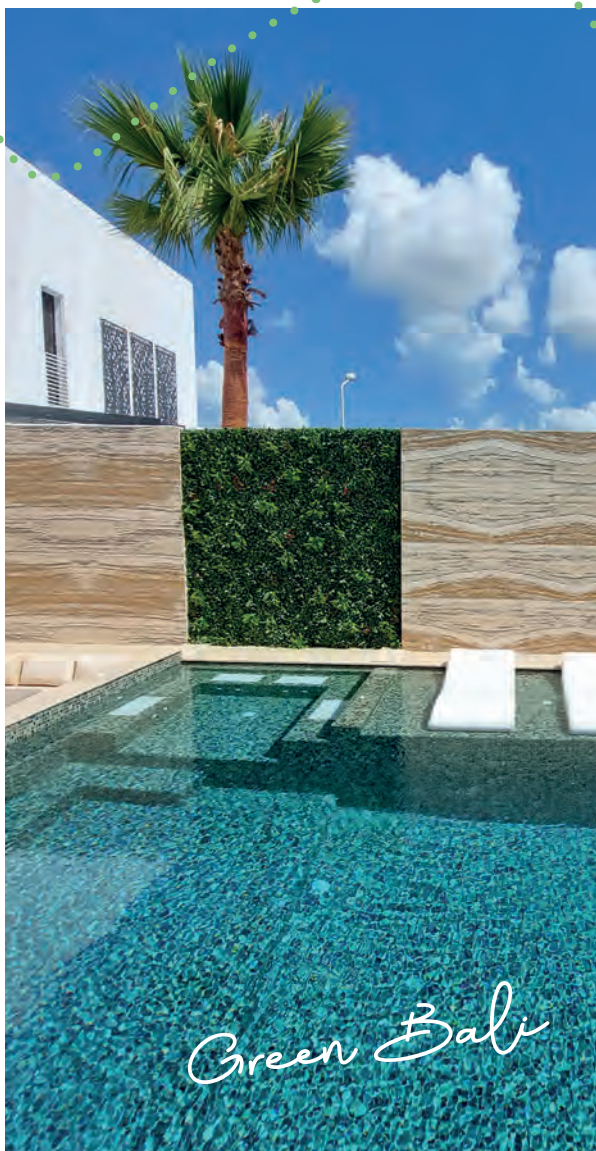

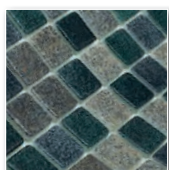

□ PA-06 5  
GREEN BALI

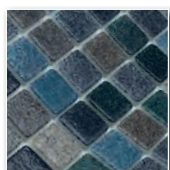

□ PA-07 5  
DEEP RIVER



□ PA-08 5  
NATURAL CREEK

Color junta - Grout color - Joint couleur : 





Dk-87





# Brave

*Waters*

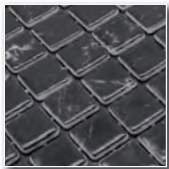

KA-04 6  
BLACK MARBLE

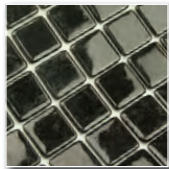

PS-26 1

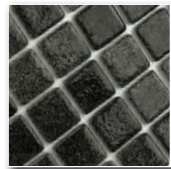

PS-54 1



DK-75 4

Color junta - Grout color - Joint couleur : 



*PS-26*



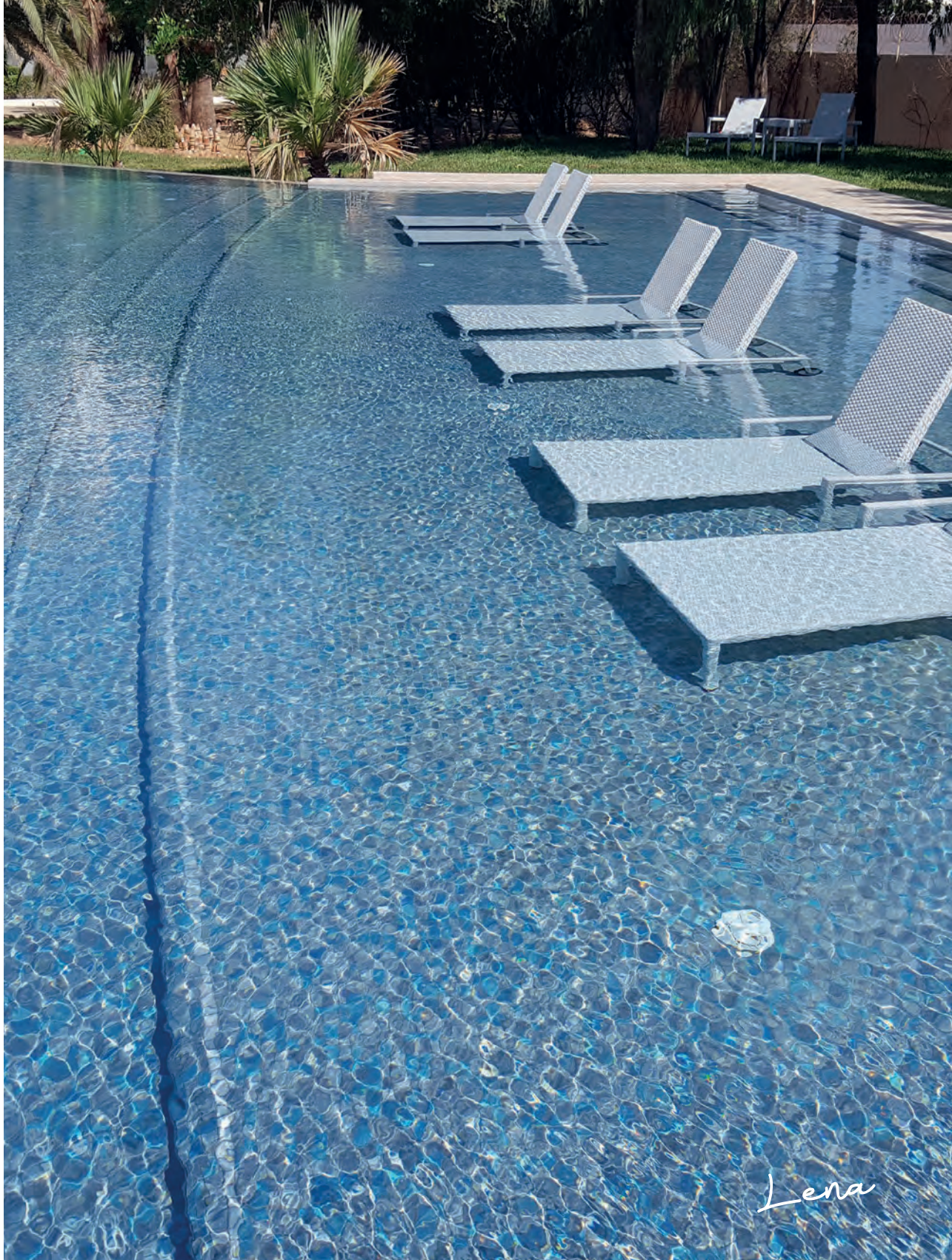

□ AB-14 2

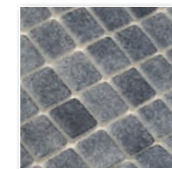

□ DK-92 4

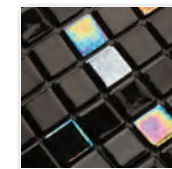

□ MIX IRIS 4  
MARKINA

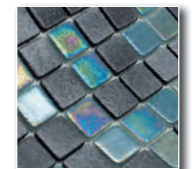

□ MIX IRIS 4  
LENA

Color junta - Grout color - Joint couleur :





*Markina*

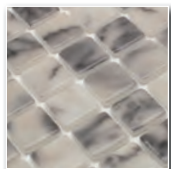

□ □ KA-03 6  
SMOKY



□ □ DK-72 4

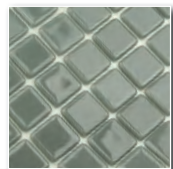

□ GRIS 4

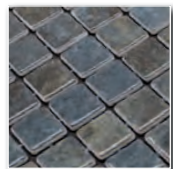

□ □ KA-08 6  
ALOHA

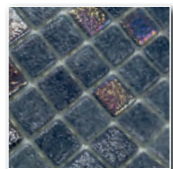

□ MIX IRIS 4  
TER

Color junta - Grout color - Joint couleur :



*Murray*





*Murray*



*Pluton*

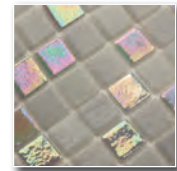

MIX IRIS 4  
VOLGA



MIX IRIS 4  
MURRAY

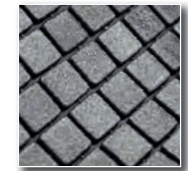

PLUTON 4

Color junta - Grout color - Joint couleur :



# Luminis pool

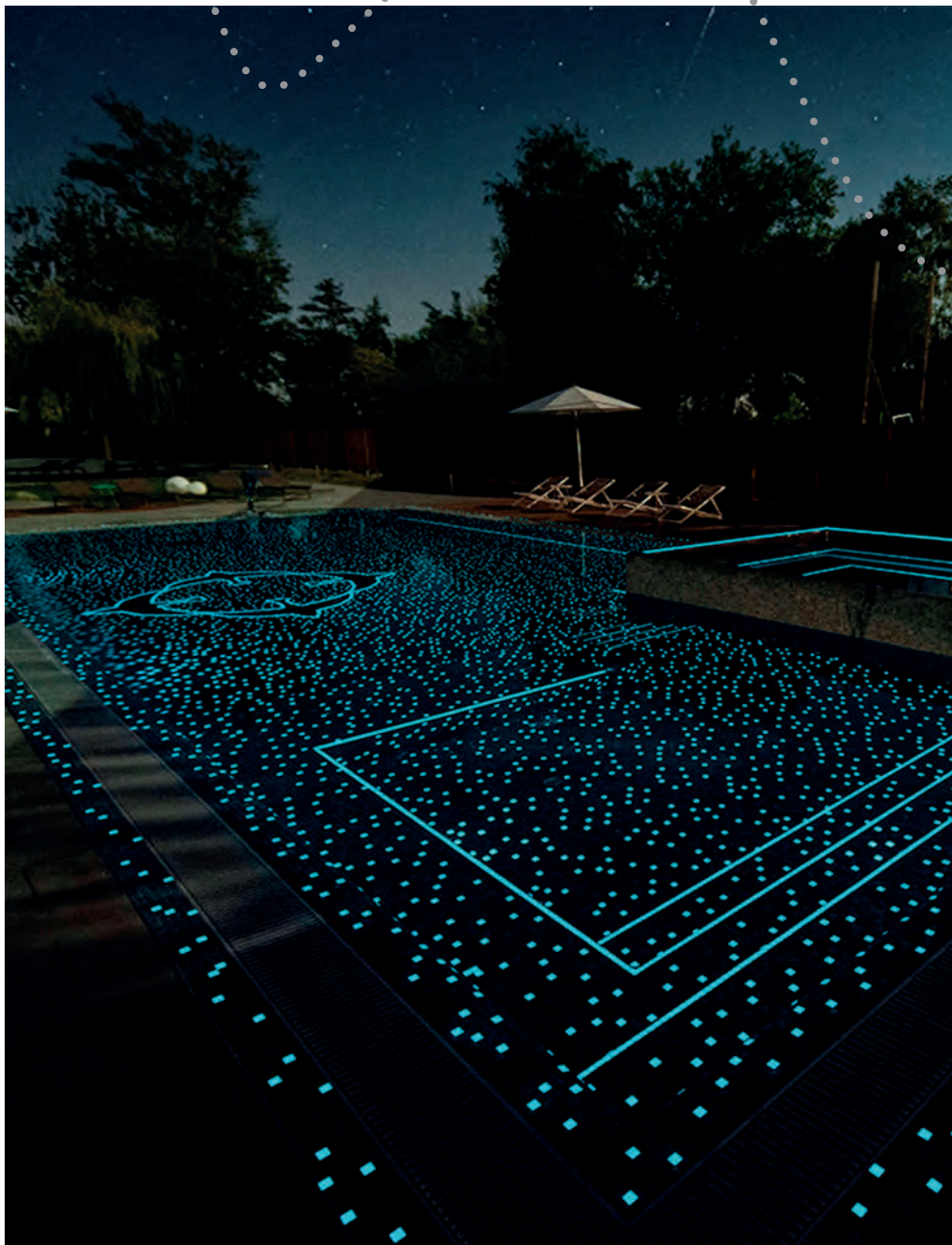

**ESP** LUMINIS luce en la oscuridad después de su exposición a una fuente de luz natural o artificial.

El mayor o menor efecto de luminiscencia del mosaico LUMINIS dependerá del tipo de luz, de su incidencia directa o indirecta, del entorno y del tiempo de exposición. La luz solar es la más efectiva sobre todo con una incidencia directa. Este efecto se prolongará varias horas, disminuyendo gradualmente su intensidad durante ese tiempo hasta su extinción total.

Luminis cumple funciones de señalética, de seguridad y como decoración.

**ENG** LUMINIS glows in the dark after exposure to a natural or artificial light source. The greater or lesser luminescence effect of the LUMINIS mosaic will depend on the type of light, its direct or indirect incidence, the environments and the exposure time. Sunlight is the most effective, especially with direct incidence. This effect will last several hours, gradually decreasing its intensity during that time until its total extinction.

Luminis fulfills signage, security, and decorative functions.

**FR** LUMINIS brille dans le noir après exposition à une source de lumière naturelle ou artificielle.

L'effet de luminescence plus ou moins important de la mosaïque LUMINIS dépendra du type de lumière, de son incidence directe ou indirecte, de l'environnement et du temps d'exposition. La lumière du soleil est la plus efficace, surtout avec une incidence directe.

Cet effet durera plusieurs heures, diminuant progressivement son intensité pendant ce temps jusqu'à son extinction totale.

Luminis accomplit les fonctions de signalétique, de sécurité et de décoration.

+ info





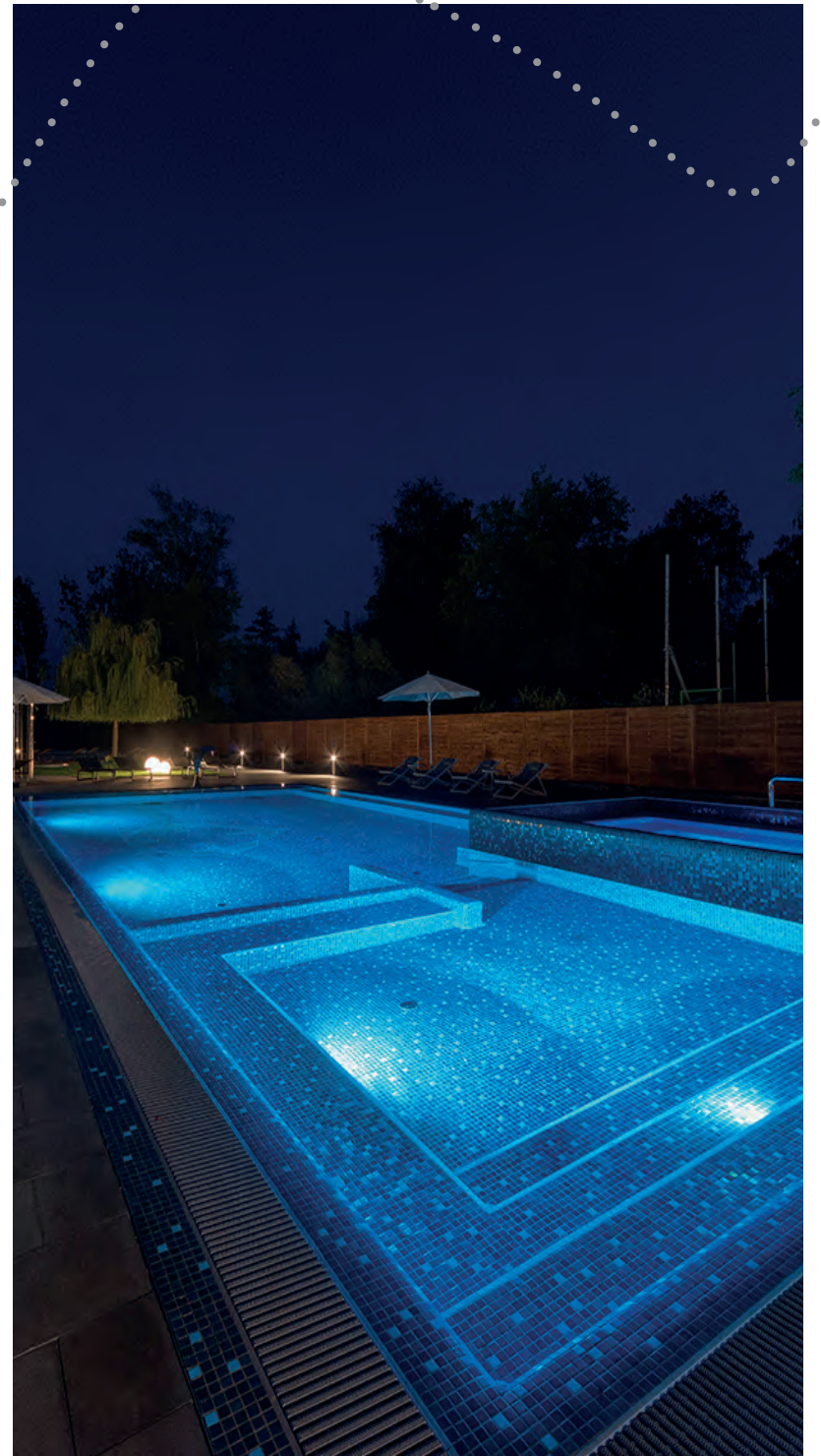



# Projects

*pool*









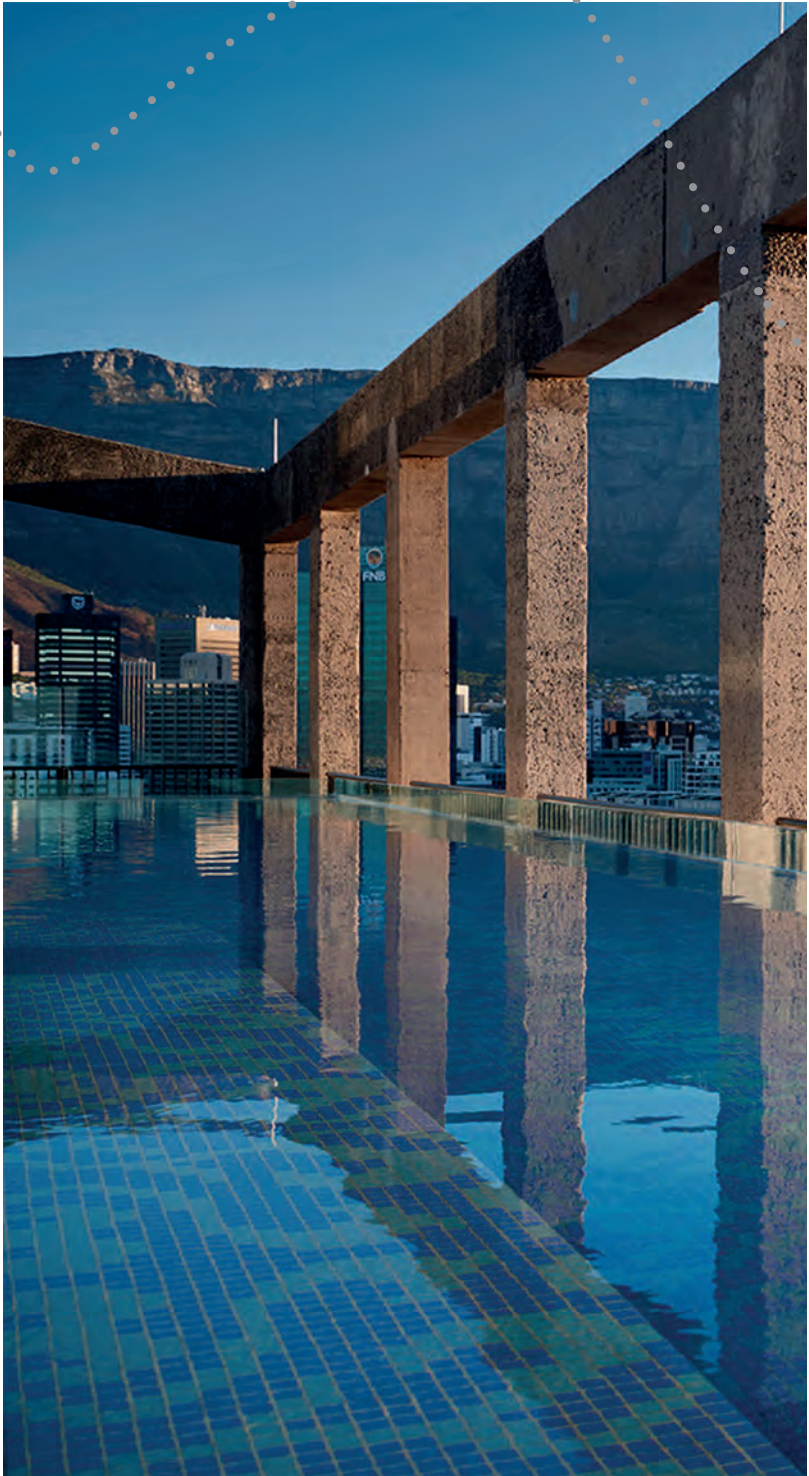



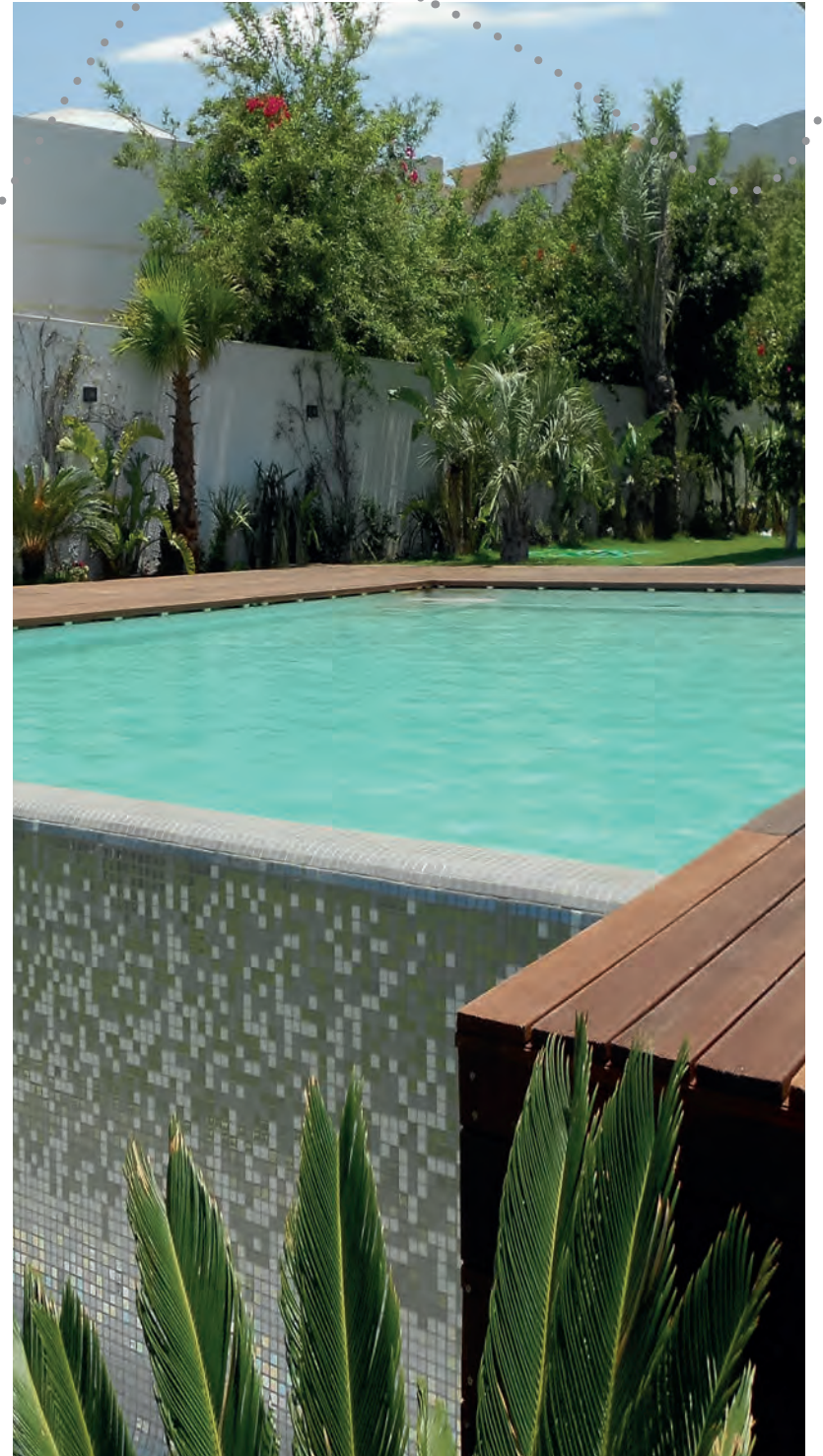











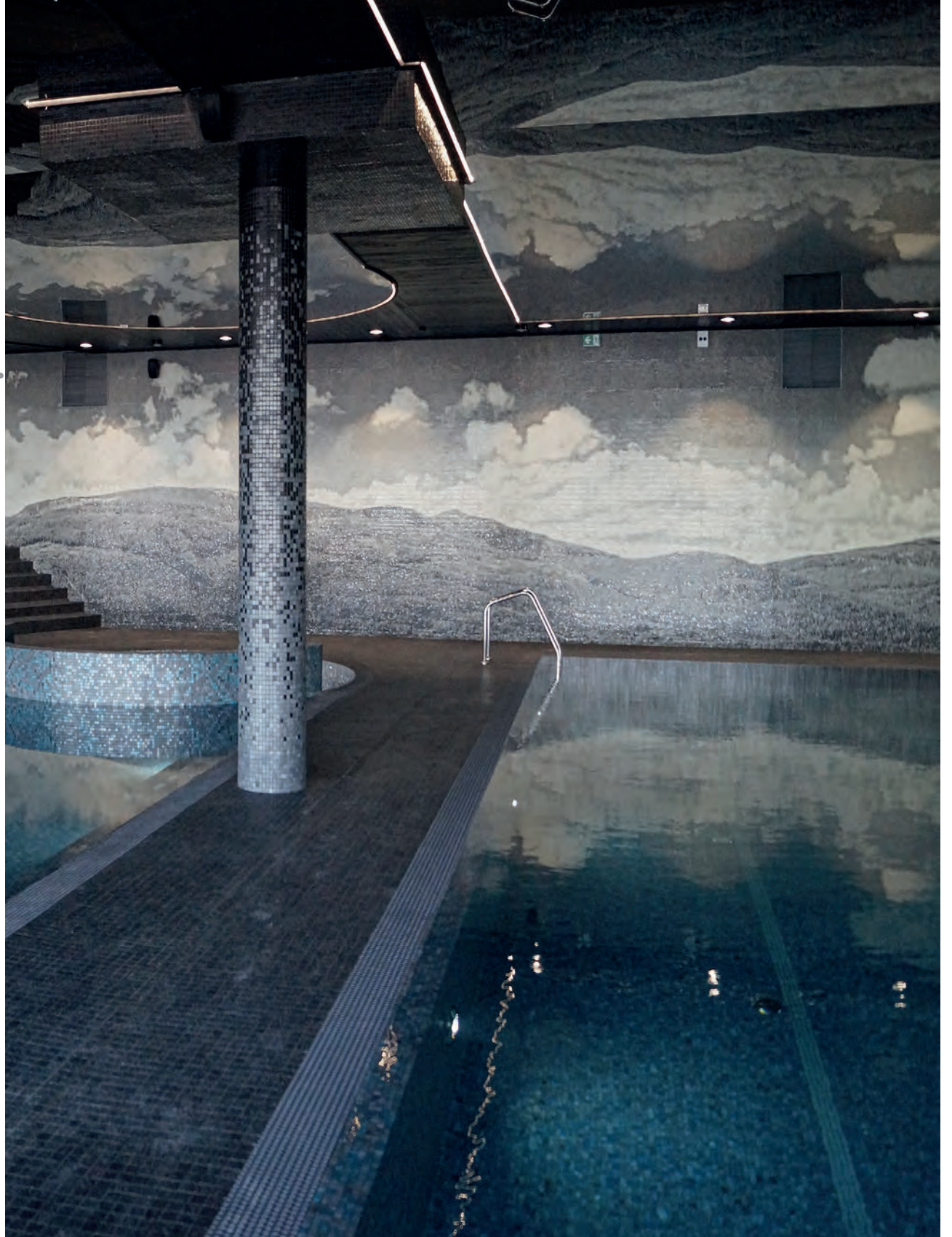







# Antislip *pool* **PATENTED**

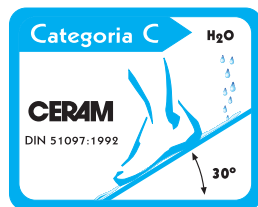
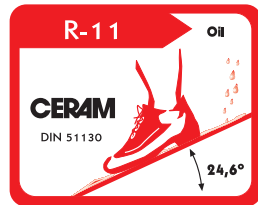
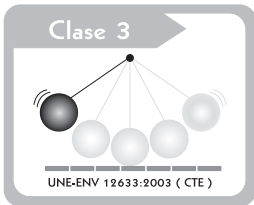
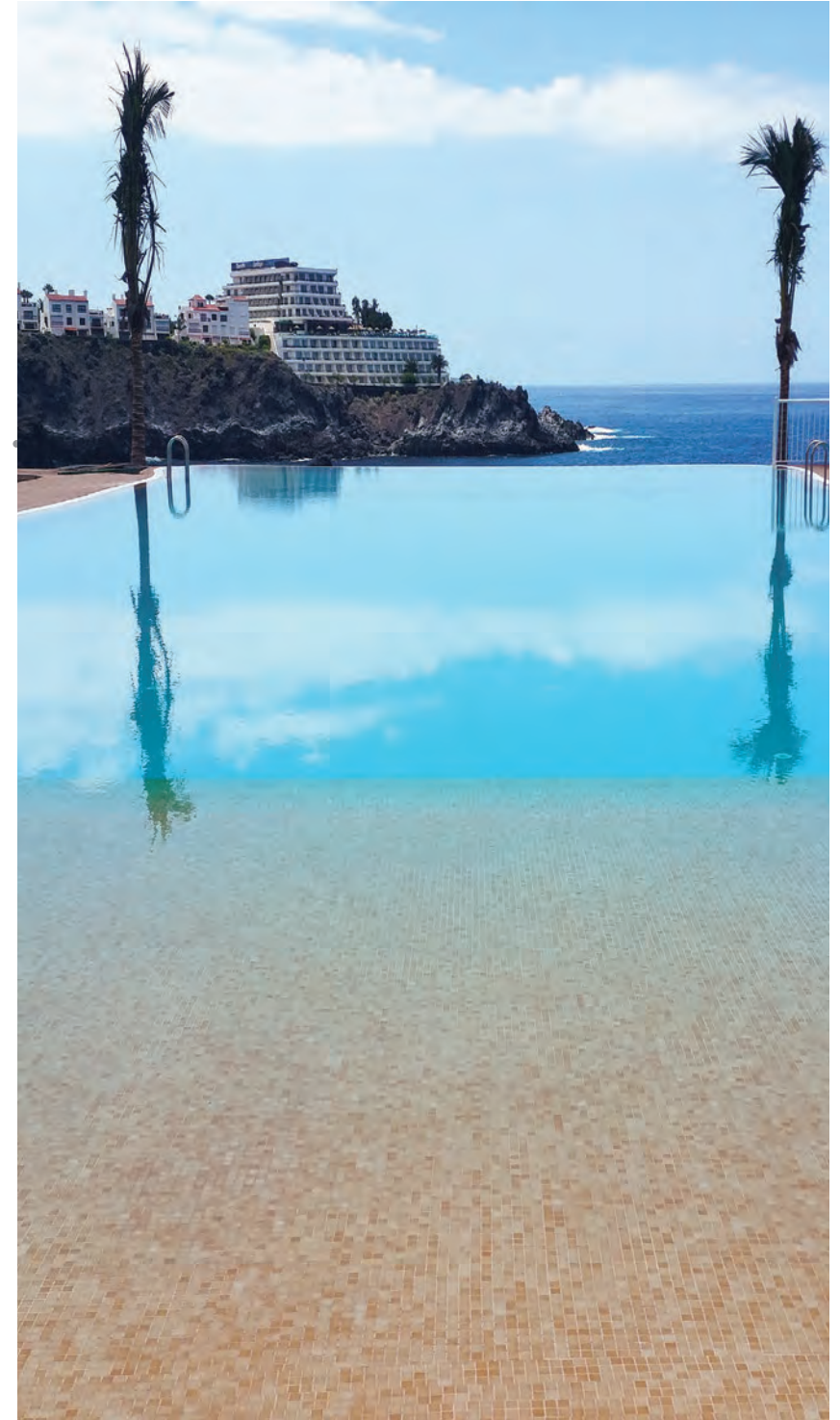

- |                          |                      |                        |
|--------------------------|----------------------|------------------------|
| ■ No abrasivo            | ■ Non abrasive       | ■ Non abrasif          |
| ■ Sedoso al tacto        | ■ Silky to touch     | ■ Soyeux au toucher    |
| ■ Rejuntado simple       | ■ Simple grouting    | ■ Jointoiment simple   |
| ■ Limpieza sencilla      | ■ Fast cleaning      | ■ Nettoyage rapide     |
| ■ Fácil mantenimiento    | ■ Easy maintenance   | ■ Facile entretien     |
| ■ Para toda la colección | ■ On the whole range | ■ Sur toute la gamme   |
| ■ Diseños personalizados | ■ Customized designs | ■ Motifs personnalisés |



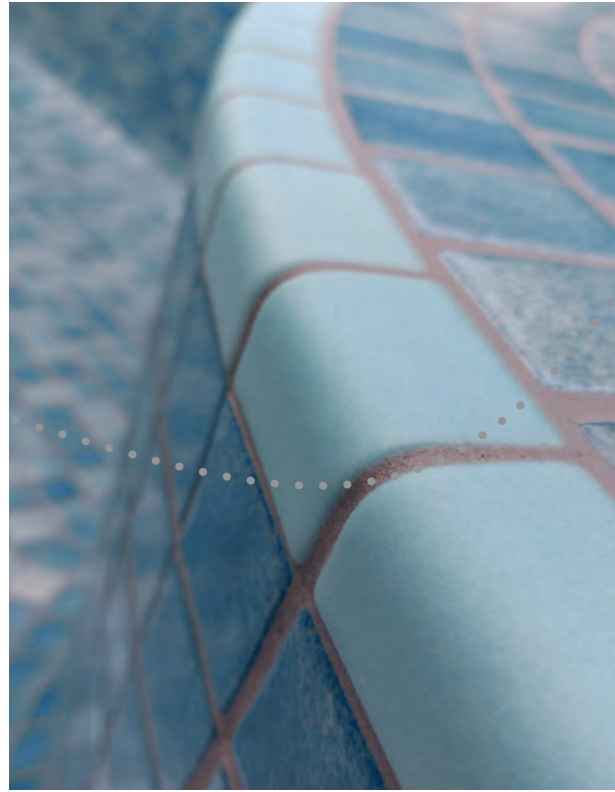

# Trim *pool*

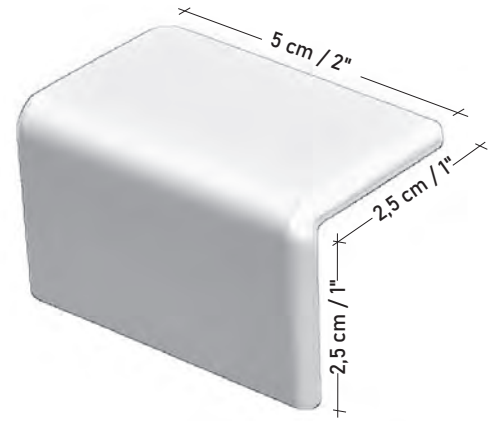



# P.U. Cord

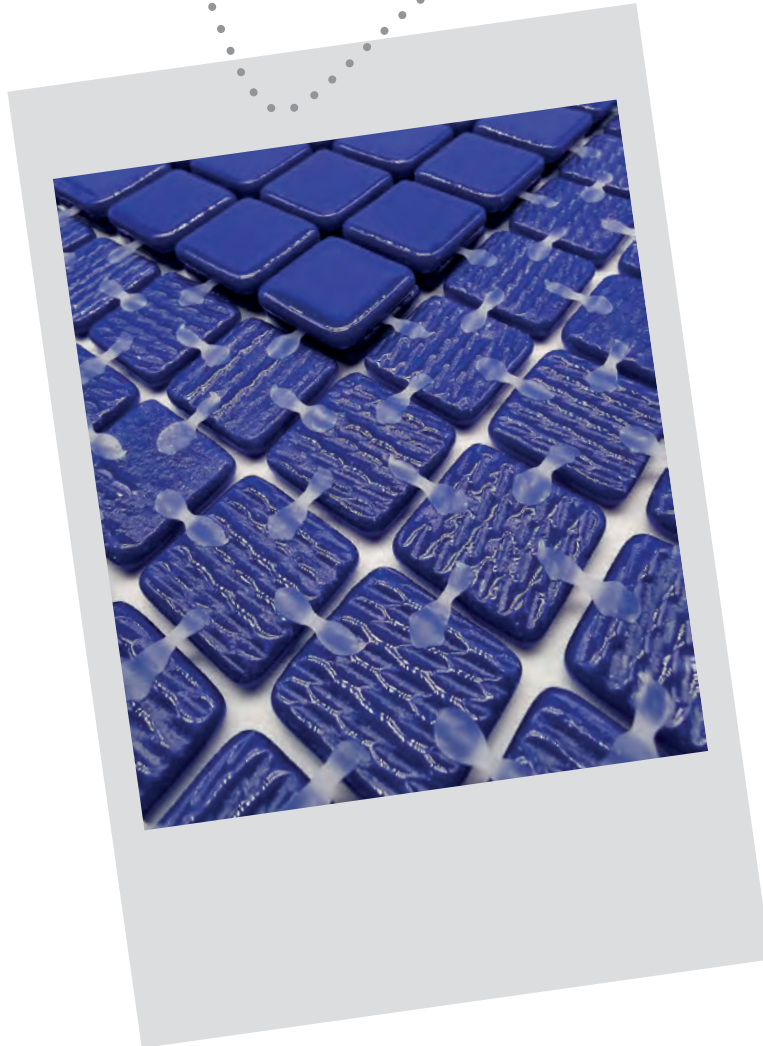

TÉCNICAMENTE AVANZADO, PRECISO Y FIABLE  
TECHNICALLY ADVANCED, PRECISE AND RELIABLE  
TECHNIQUEMENT ÉVOLUÉ, PRÉCIS ET FIABLE

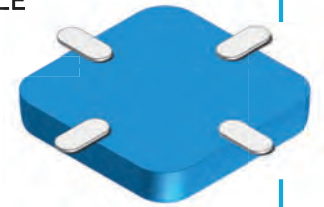

ACABADOS DE CALIDAD  
HIGH-QUALITY FINISHES  
FINITIONS DE QUALITÉ



AHORRO DE TIEMPO  
TIME SAVING  
GAIN DE TEMPS

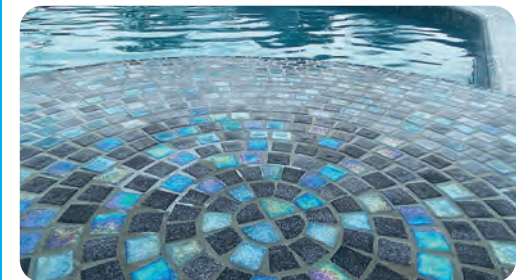
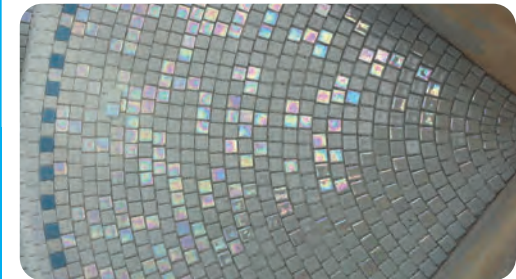

+ info  
[www.reviglass.es](http://www.reviglass.es)



<b>1</b>	<b>SERIE PS</b>
	PS-21, PS-22, PS-23, PS-24, PS-25, PS-26, PS-27, PS-40, PS-41, PS-50, PS-51, PS-52, PS-53, PS-54, PS-55, PS-56, PS-59, PS-60, PS-62, PS-63
<b>2</b>	<b>SERIE PS-IRIS</b>
	AB-02, AB-03, AB-14, PS-50 IRIS, PS-53 IRIS, PS-55 IRIS, PS-60 IRIS
<b>3</b>	<b>SERIE PS-MIX IRIS</b>
	MIX IRIS UROLA, MIX IRIS ORIA, MIX IRIS URUMEA, MIX IRIS BIDASOA, MIX IRIS ERNIO, MIX IRIS DEBA, MIX IRIS CHAVON, MIX IRIS ADUR
<b>4</b>	<b>POOL SELECTION 2</b>
	DK-70, DK-72, DK-74, DK-75, DK-84, DK-87, DK-92, GRIS, GIAVA, TAHITI, COCOS, SAMOA, PLUTON, MIX IRIS TAMESIS, MIX IRIS TIGRIS, MIX IRIS NILO, MIX IRIS DANUBIO, MIX IRIS TIBER, MIX IRIS VOLGA, MIX IRIS TER, MIX IRIS SENA, MIX IRIS INDO, MIX IRIS ORINOCO, MIX IRIS EBRO, MIX IRIS MURRAY, MIX IRIS LENA, MIX IRIS MARKINA
<b>5</b>	<b>PARADISE STONES</b>
	PA-01 AGUAMARINA, PA-02 JADE, PA-03 ZAFIRO, PA-04 SANDY BALI, PA-05 BLUE BALI, PA-06 GREEN BALI PA-07 DEEP RIVER, PA-08 NATURAL CREEK, PA-09 SANDSTONE, PA-10 TURQUESE LAGOON
<b>6</b>	<b>KARMA</b>
	KA-01 CALACATTA, KA-02 TRAVERTINE, KA-03 SMOKY, KA-04 BLACK MARBLE, KA-05 URA, KA-06 MOANA, KA-07 BALI STONE, KA-08 ALOHA, KA-09 BLUE MOON, KA-10 WALLIS, KA-11 CORAL, KA-12 AQUARELA





 Ctra. Tolosa - Azpeitia, km.8  
20496 BIDANIA ( Guipúzcoa )  
SPAIN

**reviglass**  
mosaic

ONDA ( Castellón )

Almacén Logístico  
Logistic Unit  
Dépôt logistique



   **YouTube**  
@reviglassmosaic

export@reviglass.es • comercial@reviglass.es • www.reviglass.es  
Telf: (+34) 943 681 118 • Fax: (+34) 943 681 129

**ESP** Los colores que se reflejan en esta guía son aproximados por tratarse de reproducciones fotográficas. **ENG** The colors shown on this guide are approximate only, as all are photographic reproductions.

**FR** Les couleurs montrées dans cette guide ne sont qu'approximatives car il s'agit de reproductions photographiques.